

Internal Resistance Tester

IT5101 Programming Guide

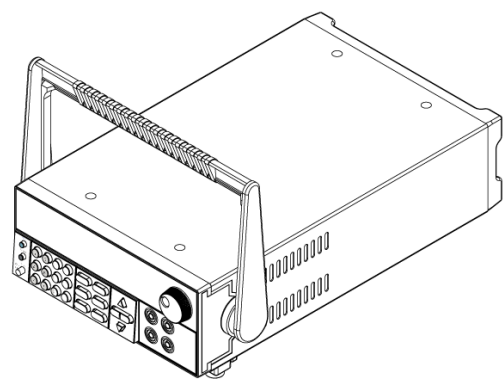

Model: IT5101/IT5101E/IT5101H
Version: 1.0

Notices

© Itech Electronic, Co., Ltd. 2017
No part of this manual may be reproduced in any form or by any means (including electronic storage and retrieval or translation into a foreign language) without prior permission and written consent from Itech Electronic, Co., Ltd. as governed by international copyright laws.

Manual Part Number

IT5101-402156

Revision

2nd Edition: Nov 15, 2017
Itech Electronic, Co., Ltd.

Trademarks

Pentium is U.S. registered trademarks of Intel Corporation.

Microsoft, Visual Studio, Windows and MS Windows are registered trademarks of Microsoft Corporation in the United States and/or other countries and regions.

Warranty

The materials contained in this document are provided “as is”, and is subject to change, without prior notice, in future editions. Further, to the maximum extent permitted by applicable laws, ITECH disclaims all warranties, either express or implied, with regard to this manual and any information contained herein, including but not limited to the implied warranties of merchantability and fitness for a particular purpose. ITECH shall not be held liable for errors or for incidental or indirect damages in connection with the furnishing, use or application of this document or of any information contained herein. Should ITECH and the user enter into a separate written agreement with warranty terms covering the materials in this document that conflict with these terms, the warranty terms in the separate agreement shall prevail.

Technology Licenses

The hardware and/or software described herein are furnished under a license and may be used or copied only in accordance with the terms of such license.

Restricted Rights Legend

Restricted permissions of the U.S. government. Permissions for software and technical data which are authorized to the U.S. Government only include those for custom provision to end users. ITECH provides this customary commercial license in software and technical data pursuant to FAR 12.211 (Technical Data) and 12.212 (Computer Software) and, for the Department of Defense, DFARS 252.227-7015 (Technical Data – Commercial Items) and DFARS 227.7202-3 (Rights in Commercial Computer Software or Computer Software Documentation).

Safety Notices

CAUTION

A CAUTION sign denotes a hazard. It calls attention to an operating procedure or practice that, if not correctly performed or adhered to, could result in damage to the product or loss of important data. Do not proceed beyond a CAUTION sign until the indicated conditions are fully understood and met.

WARNING

A WARNING sign denotes a hazard. It calls attention to an operating procedure or practice that, if not correctly performed or adhered to, could result in personal injury or death. Do not proceed beyond a WARNING sign until the indicated conditions are fully understood and met.



NOTE

A NOTE sign denotes important hint. It calls attention to tips or supplementary information that is essential for users to refer to.

Quality Certification and Assurance

We certify that IT5101 meets all the published specifications at time of shipment from the factory.

Warranty

ITECH warrants that the product will be free from defects in material and workmanship under normal use for a period of one (1) year from the date of delivery (except those described in the Limitation of Warranty below).

For warranty service or repair, the product must be returned to a service center designated by ITECH.















- The product returned to ITECH for warranty service must be shipped PREPAID. And ITECH will pay for return of the product to customer.
- If the product is returned to ITECH for warranty service from overseas, all the freights, duties and other taxes shall be on the account of customer.

Limitation of Warranty

This Warranty will be rendered invalid if the product is:

- Damaged resulting from customer-wired circuits or customer-supplied parts or accessories;
- Modified or repaired by customer without authorization;
- Damaged resulting from customer-wired circuits or use in an environment not designated by us;
- The product model or serial number is altered, deleted, removed or made illegible by customer;
- Damaged as a result of accidents, including but not limited to lightning, moisture, fire, improper use or negligence.

Safety Symbols

	Direct current		ON (power)
	Alternating current		OFF (power)
	Both direct and alternating current		Power-on state
	Chassis (earth ground) symbol.		Power-off state
	Earth (ground) terminal		Reference terminal
	Caution		Positive terminal
	Warning (refer to this manual for specific Warning or Caution information)		Negative terminal

	A chassis terminal	-	-
---	--------------------	---	---

Safety Precautions

The following safety precautions must be observed during all phases of operation of this instrument. Failure to comply with these precautions or specific warnings elsewhere in this manual will constitute a default under safety standards of design, manufacture and intended use of the instrument. ITECH assumes no liability for the customer's failure to comply with these precautions.

WARNING

- Do not use the instrument if it is damaged. Before operation, check the casing to see whether it cracks. Do not operate the instrument in the presence of inflammable gasses, vapors or dusts.
- The instrument is provided with a power line during delivery and should be connected to junction box. Before operation, be sure that the instrument is well grounded. Make sure to use the power cord supplied by ITECH.
- Check all marks on the instrument before connecting the instrument to power supply.
- Use electric wires of appropriate load. All loading wires should be capable of bearing maximum short-circuit of electronic load without overheating. If there are multiple loads, each pair of the load power cord must be carry out the full rated short-circuit output current of the power securely.
- Ensure the voltage fluctuation of mains supply is less than 10% of the working voltage range in order to reduce risks of fire and electric shock.
- Do not install alternative parts on the instrument or perform any unauthorized modification.
- Do not use the instrument if the detachable cover is removed or loosen.
- To prevent the possibility of accidental injuries, be sure to use the power adapter supplied by the manufacturer only.
- We do not accept responsibility for any direct or indirect financial damage or loss of profit that might occur when using the instrument.
- This instrument is used for industrial purposes. Do not apply this product to IT power supply system.
- Never use the instrument with a life-support system or any other equipment subject to safety requirements.

CAUTION

- Failure to use the instrument as directed by the manufacturer may render its protective features void.
- Always clean the casing with a dry cloth. Do not clean the internals.
- Make sure the vent hole is always unblocked.

Environmental Conditions

The instrument is designed for indoor use and an area with low condensation. The table below shows the general environmental requirements for the instrument.



Environmental Conditions	Requirements
Operating temperature	0°C to 40°C
Operating humidity	20%-80% (non-condensation)
Storage temperature	-10°C to 70 °C
Altitude	Operating up to 2,000 meters
Installation category	II
Pollution degree	Pollution degree 2



Note

To make accurate measurements, allow the instrument to warm up for 30 min.

Regulatory Markings

	The CE mark indicates that the product complies with all the relevant European legal directives. The specific year (if any) affixed refers to the year when the design was approved.
	The instrument complies with the WEEE Directive (2002/96/EC) marking requirement. This affix product label indicates that you must not discard the electrical/electronic product in domestic household waste.
	This symbol indicates the time period during which no hazardous or toxic substances are expected to leak or deteriorate during normal use. The expected useful life of the product is 10 years. The product can be used safely during the 10-year Environment Friendly Use Period (EFUP). Upon expiration of the EFUP, the product must be immediately recycled.

Waste Electrical and Electronic Equipment (WEEE) Directive



2002/96/EC Waste Electrical and Electronic Equipment (WEEE) Directive

This product complies with the WEEE Directive (2002/96/EC) marking requirement. This affix product label indicates that you must not discard the electrical/electronic product in domestic household waste.

Product Category

With reference to the equipment classifications described in the Annex 1 of the WEEE Directive, this instrument is classified as

a “Monitoring and Control Instrument”.
To return this unwanted instrument, contact your nearest
ITECH office.

Compliance Information

Complies with the essential requirements of the following applicable European Directives, and carries the CE marking accordingly:

- Electromagnetic Compatibility (EMC) Directive 2014/30/EU
- Low-Voltage Directive (Safety) 2014/35/EU

Conforms with the following product standards:

EMC Standard

IEC 61326-1:2012/ EN 61326-1:2013 ¹²³

Reference Standards

CISPR 11:2009+A1:2010/ EN 55011:2009+A1:2010 (Group 1, Class A)

IEC 61000-4-2:2008/ EN 61000-4-2:2009

IEC 61000-4-3:2006+A1:2007+A2:2010/ EN 61000-4-3:2006+A1:2008+A2:2010

IEC 61000-4-4:2004+A1:2010/ EN 61000-4-4:2004+A1:2010

IEC 61000-4-5:2005/ EN 61000-4-5:2006

IEC 61000-4-6:2008/ EN 61000-4-6:2009

IEC 61000-4-11:2004/ EN 61000-4-11:2004

1. The product is intended for use in non-residential/non-domestic environments. Use of the product in residential/domestic environments may cause electromagnetic interference.
2. Connection of the instrument to a test object may produce radiations beyond the specified limit.
3. Use high-performance shielded interface cable to ensure conformity with the EMC standards listed above.

Safety Standard

IEC 61010-1:2010/ EN 61010-1:2010

Content

Quality Certification and Assurance	I
Warranty	I
Limitation of Warranty	I
Safety Symbols	I
Safety Precautions.....	II
Environmental Conditions	III
Regulatory Markings	III
Waste Electrical and Electronic Equipment (WEEE) Directive.....	III
Compliance Information	IV
Chapter1 Remote Control	1
1.1 Overview	1
1.2 SCPI Command Introduction	1
1.3 Command Type	1
1.4 Message Type	3
1.5 Response Data Type	5
1.6 Command Format	6
1.7 Data Type	8
1.8 Communication Interface	9
Chapter2 System Command	10
SYSTEM:BEEPer :STATe <1 0 ON OFF>	10
SYSTEM:LFRequency <50 60>	10
SYSTEM:KLOCK <1 0 ON OFF>	11
SYSTEM:ELock <1 0 ON OFF>	11
SYSTEM:LOCAl	11
SYSTEM:SAVE <1-126>	12
SYSTEM:READ <1-126>	12
SYSTEM:BACKUp	12
SYSTEM:HEADer <1 0 ON OFF>.....	13
SYSTEM:ERRor <ASYNchronous SYNchronous>	13
SYSTEM:TERMinator <0 1>	13
SYSTEM:EOM:MODE.....	14
SYSTEM:EOM:PULSe	14
SYSTEM:CURRent <CONTInuous PLUSe>	14
SYSTEM:RESet	15
IO:OUT<0-1024>	15
IO:IN?	15
INITiate:CONTInuous<1 0 ON OFF>	15
INITiate[:IMMediate]	16
TRIGger:SOURce<IMMediate EXternal>	16
TRIGger:DElay:STATe<1 0 ON OFF>	16
TRIGger:DElay<0-9.999>.....	16
FETCh?	17
READ?.....	17
Chapter3 Configuration Commands	18
ESE0 <0-255>.....	18
ESE1 <0-255>.....	18
FUNCTion <RV RESistance VOLTage>	19
RESistance:RANGe <0-3100>	19
RESistance:RANGe<0-3.1>	19
VOLTage:RANGe <-300 - 300>	20
VOLTage:RANGe <-1000~1000>	20
AUTorange <1 0 ON OFF>	20
AUTorange:VOLTage <1 0 ON OFF>	21
AUTorange:RESistance <1 0 ON OFF>.....	21

ADJust:CLEAr	22
ADJust?.....	22
SAMPlE:RATE <SLOW MEDium FAST EXFast>	22
CALCulate:AVERAge:STATe <1 0 ON OFF>	23
CALCulate:AVERAge <2-16>.....	23
CALCulate:LIMit:STATe <1 0 ON OFF>.....	24
CALCulate:LIMit:ALARm <DISPlay BEEPer ALL>.....	24
CALCulate:LIMit:RESistance:MODE <HL REF>	25
CALCulate:LIMit:VOLTagE:MODE <HL REF>	25
CALCulate:LIMit:RESistance:UNIT <MR R>	25
CALCulate:LIMit:RESistance:UPPer <0-99999>	26
CALCulate:LIMit:VOLTagE:UPPer <0-999999>	26
CALCulate:LIMit:RESistance:LOWer <0-99999>	27
CALCulate:LIMit:VOLTagE:LOWer <0-999999>	28
CALCulate:LIMit:RESistance:REFerence<0-99999>	28
CALCulate:LIMit:VOLTagE:REFerence <0-999999>	29
CALCulate:LIMit:RESistance:PERCent <0-99.9999>.....	29
CALCulate:LIMit:VOLTagE:PERCent <0-99.9999>	30
CALCulate:LIMit:RESistance:RESult?	30
CALCulate:LIMit:VOLTagE:RESult?	31
CALCulate:LIMit:ABS <1/0/ON/OFF>	31
CALCulate:STATistics:STATe <1 0 ON OFF>	31
CALCulate:STATistics:CLEAr	32
CALCulate:STATistics:RESistance:NUMBer?.....	32
CALCulate:STATistics:VOLTagE:NUMBer?	32
CALCulate:STATistics:RESistance:MEAN?	33
CALCulate:STATistics:VOLTagE:MEAN?	33
CALCulate:STATistics:RESistance:MAXimum?.....	33
CALCulate:STATistics:VOLTagE:MAXimum?	33
CALCulate:STATistics:RESistance:MINimum?	33
CALCulate:STATistics:VOLTagE:MINimum?	34
CALCulate:STATistics:RESistance:LIMit?	34
CALCulate:STATistics:VOLTagE:LIMit?	34
CALCulate:STATistics:RESistance:DEViation?.....	34
CALCulate:STATistics:VOLTagE:DEViation?	34
CALCulate:STATistics:RESistance:CP?	35
CALCulate:STATistics:VOLTagE:CP?	35
MEMory:CLEAr	35
MEMory:COUNT?	36
Chapter4 IEEE-488 Commands	37
*IDN?.....	37
*RST.....	37
*TST.....	37
*WAI.....	38
*CLS.....	38
*ESE <0-255>.....	38
*ESR <0-255>	39
*SRE <0-255>	39
*STB?.....	40
*TRG.....	40

Chapter1 Remote Control

1.1 Overview

This chapter will provide following remote configuration introductions:

- SCPI Command Introduction
- Command type
- Message Type
- Response Data Type
- Command format
- Data format
- Remote Operation

1.2 SCPI Command Introduction

SCPI is short for Standard Commands for Programmable Instruments which defines a communication method of bus controller and instrument. It is based on ASCII and supply for testing and measuring instruments. SCPI command is based on hierarchical architecture which also known as tree system. In this system, Relevant Command is returned to a common node or root, so that a subsystem is formed.

A part of OUTPUT subsystem is listed below:

OUTPUT:

SYNC {OFF|0|ON|1}

SYNC:

MODE {NORMAL|CARRIER}

POLARITY {NORMAL|INVERTED}

OUTPUT is the root class keyword, SYNC is the second keyword, MODE and POLARITY are the third keyword. Colon(:) is used for separating the command keyword and the next level keyword.

1.3 Command Type

SCPI has two types of commands, common and subsystem.

- Common commands generally are not related to specific operation but to controlling overall electronic load functions, such as reset, status, and synchronization. All common commands consist of a three-letter mnemonic preceded by an asterisk: *RST *IDN? *SRE 8.
- Subsystem commands perform specific electronic load functions. They are organized into an inverted tree structure with the "root" at the top. The following figure shows a portion of a subsystem command tree, from which you access the commands located along the various paths.

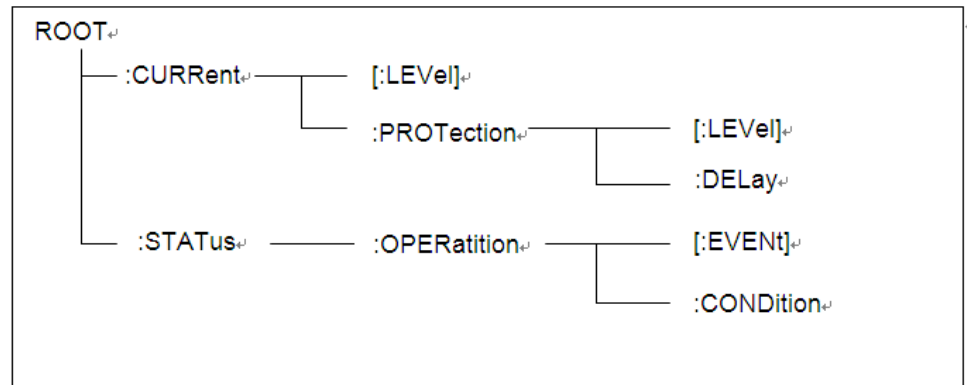

Multiple commands in a message

Multiple SCPI commands can be combined and sent as a single message with one message terminator. There are two important considerations when sending several commands within a single message:

- Use a semicolon to separate commands within a message.
- Head paths influence how the instrument interprets commands.

We consider the head path as a string which will be inserted in front of every command of a message. As for the first command of a message, the head path is a null string; for each subsequent command, the head path is a string which is defined to form the current command until and including the head of the last colon separator. A message with two combined commands: `CURR:LEV 3;PROT:STAT OFF`

The example indicates the effect of semicolon and explains the concept of head path. Since the head path is defined to be "CURR" after "curr: lev 3", the head of the second command, "curr", is deleted and the instrument explains the second command as: `CURR:PROT:STAT OFF`

If "curr" is explicitly included in the second command, it is semantically wrong. Since combining it with the head path will become "CURR:CURR:PROT:STAT OFF", resulting in wrong command.

Movement in the subsystem

In order to combine commands from different subsystems, you need to be able to reset the header path to a null string within a message. You do this by beginning the command with a colon (:), which discards any previous header path. For example, you could clear the output protection and check the status of the Operation Condition register in one message by using a root specifier as follows:

```
PROTection:CLEAr;:STATus:OPERation:CONDition?
```

The following message shows how to combine commands from different subsystems as well as within the same subsystem:

```
POWeR:LEVel 200;PROTection 28; :CURRent:LEVel 3;PROTection:STATe ON
```

Note the use of the optional header LEVel to maintain the correct path within the voltage and current subsystems, and the use of the root specifier to move between subsystems.

Including Common Commands

You can combine common commands with subsystem commands in the same message. Treat the common command as a message unit by separating it with a semicolon (the message unit separator). Common commands do not affect the header path; you may insert them anywhere in the message.

```
VOLTage:TRIGgered 17.5;:INITialize;*TRG
```

```
OUTPut OFF;*RCL 2;OUTPut ONIT872X-3X SCPI Communication protocol 17
```

Case sensitivity

Common commands and SCPI commands are not case sensitive. You can use upper or lower, for example:

```
*RST = *rst
```

```
:DATA? = :data?
```

```
:SYSTem:PRESet = :system:preset
```

Long-form and short-form versions

A SCPI command word can be sent in its long-form or short-form version. The command subsystem tables in Section 5 provide the in the long-form version. However, the short-form version is indicated by upper case characters. Examples:

```
:SYSTem:PRESet long-form
```

```
:SYST:PRES short form
```

```
:SYSTem:PRES long-form and short-form combination
```

Note that each command word must be in long-form or short-form, and not something in between.

For example, :SYSTe:PRESe is illegal and will generate an error. The command will not be executed.

Query

Observe the following precautions with queries:

- Set up the proper number of variables for the returned data. For example, if you are reading back a measurement array, you must dimension the array according to the number of measurements that you have placed in the measurement buffer.
- Read back all the results of a query before sending another command to the electronic load. Otherwise a Query Interrupted error will occur and the unreturned data will be lost.

1.4 Message Type

There are two types of SCPI messages, program and response.

- program message: A program message consists of one or more properly formatted SCPI commands sent from the controller to the electronic load. The message, which may be sent at any time, requests the electronic load to perform some action.

- response message: A response message consists of data in a specific SCPI format sent from the electronic load to the controller. The electronic load sends the message only when commanded by a program message called a "query."

The next figure illustrates SCPI message structure:

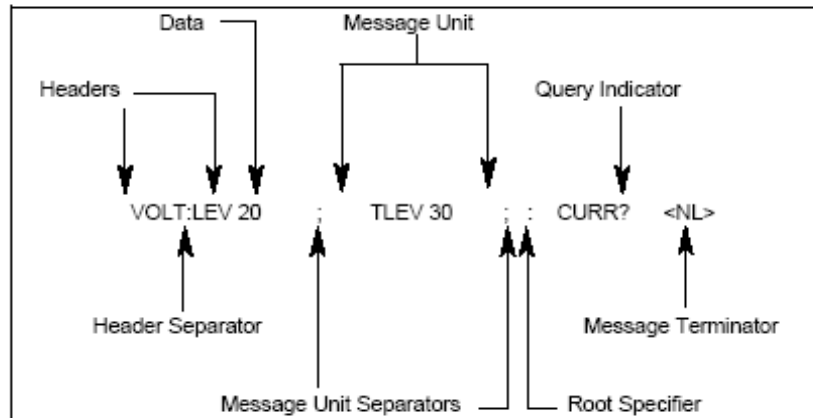

The Message Unit

The simplest SCPI command is a single message unit consisting of a command header (or keyword) followed by a message terminator. The message unit may include a parameter after the header. The parameter can be numeric or a string.

VOLTage 20<NL>

Headers

Headers, also referred to as keywords, are instructions recognized by the electronic load. Headers may be either in the long form or the short form. In the long form, the header is completely spelled out, such as VOLTAGE, STATUS, and DELAY. In the short form, the header has only the first three or four letters, such as VOLT, STAT, and DEL.

Query Indicator

Following a header with a question mark turns it into a query (VOLTage?, VOLTage:PROtection?). If a query contains a parameter, place the query indicator at the end of the last header (VOLTage:PROtection?MAX).

Message Unit Separator

When two or more message units are combined into a compound message, separate the units with a semicolon (STATus:OPERation?;QUESTionable?).

Root Specifier

When it precedes the first header of a message unit, the colon becomes the root specifier. It tells the command parser that this is the root or the top node of the command tree.

Message Terminator

A terminator informs SCPI that it has reached the end of a message. Three permitted message terminators are:

- newline (<NL>), decimal 10 or hexadecimal 0X0A in ASCII.
- end or identify (<END>)
- both of the above (<NL><END>).

In the examples of this guide, there is an assumed message terminator at the end of each message.

Command execution rules

- Commands execute in the order that they are presented in the program message.
- An invalid command generates an error and, of course, is not executed.
- Valid commands that precede an invalid command in a multiple command program message are executed.
- Valid commands that follow an invalid command in a multiple command program message are ignored.

1.5 Response Data Type

Character strings returned by query statements may take either of the following forms, depending on the length of the returned string:

<CRD>	Character Response Data. Permits the return of character strings.
<AARD>	Arbitrary ASCII Response Data. Permits the return of undelimited 7-bit ASCII. This data type has an implied message terminator.
<SRD>	String Response Data. Returns string parameters enclosed in double quotes

Response messages

A response message is the message sent by the instrument to the computer in response to a query command.

Sending a response message

After sending a query command, the response message is placed in the Output Queue. When the IT8800 Series is then addressed to talk, the response message is sent from the Output Queue to the computer.

Multiple response messages

If you send more than one query command in the same program message (see the paragraph entitled, "Multiple Command Messages"), the multiple response messages for all the queries is sent to the computer when the IT8800 Series is addressed to talk. The responses are sent in the order that the query commands were sent and are separated by semicolons (;). Items within the same query are separated by commas (,). The following example shows the response message for a program message that contains four single item query commands:

0; 1; 1; 0

Response message terminator (RMT)

Each response is terminated with an LF (line feed) and EOI (end or identify). The following example shows how a multiple response message is terminated:

0; 1; 1; 0; <RMT>

Message exchange protocol

Two rules summarize the message exchange protocol:

Rule 1. You must always tell the IT6500 Series what to send to the computer.

The following two steps must always be performed to send information from the instrument other computer:

1. Send the appropriate query command(s) in a program message.
2. Address the IT6500 Series to talk.

Rule 2. The complete response message must be received by the computer before another program message can be sent to the IT6500 Series.

1.6 Command Format

Formats for command display are as follows:

```
[SOURce[1|2]:]VOLTage:UNIT {VPP|VRMS|DBM}
```

```
[SOURce[1|2]:]FREQuency:CENTer  
{<frequency>|MINimum|MAXimum|DEFault}
```

Based on the command syntax, most commands (and certain Parameter) are expressed in both upper and lower cases. Upper case refers to abbreviation of commands. Shorter program line may send commands in abbreviated format. Long-format commands may be sent to ensure better program readability.

For example, both formats of VOLT and VOLTAGE are acceptable in the above syntax statements. Upper or lower case may be used. Therefore, formats of VOLTAGE, volt and Volt are all acceptable. Other formats (such as VOL and VOLTAG) are invalid and will cause errors.

- Parameter options with given command strings are included in the brace ({ }). The brace is not sent along with command strings.
- Vertical stripes (|) separate several parameter options with given command strings. For example, {VPP|VRMS|DBM} indicates that you may assign "APP", "VRMS" or "DBM" in the above commands. Vertical stripes are not sent along with command strings.
- Angle brackets (< >) in the second example indicates that a value must be assigned to the parameter in the brace. For example, the parameter in the angle bracket is <frequency> in the above syntax statements. Angle brackets are not sent along with command strings. You must assign a value (such as "FREQ:CENT 1000") to the parameter, unless you select other options displayed in the syntax (such as "FREQ:CENT MIN").
- Some syntax elements (such as nodes and Parameter) are included in square brackets ([]). It indicates that these elements can be selected and omitted. Angle brackets are not sent along with command strings. If no value is assigned to the optional Parameter, the instrument will select a default value. In the above examples, "SOURce[1|2]" indicates that you may refer to source channel 1 by "SOURce" or "SOURce1" or "SOUR1" or "SOUR". In addition, since the whole SOURce node is optional (in the square bracket), you can refer to the channel 1 by omitting the whole SOURce node. It is because the channel 1 is the default channel for SOURce language node. On the other hand, if you want to refer to channel 2, "SOURce2" or "SOUR2" must be used in the program line.

Colon (:)

It is used to separate key words of a command with the key words in next level.

As shown below:

```
APPL:SIN 455E3,1.15,0.0
```

In this example, APPLy command assigns a sine wave with frequency of 455 KHz, amplitude of 1.15 V and DC offset of 0.0 V.

Semicolon (;)

It is used to separate several commands in the same subsystem and can also minimize typing. For example, to send the following command string:

```
TRIG:SOUR EXT; COUNT 10
```

has the same effect as sending the following two commands:

```
TRIG:SOUR EXT  
TRIG:COUNT 10
```

Question mark (?)

You can insert question marks into a command to query current values of most Parameter. For example, the following commands will trigger to set the count as 10:

```
TRIG:COUN 10
```

Then, you may query count value by sending the following command:

```
TRIG:COUN?
```

You may also query the allowable minimum or maximum count as follows:

```
TRIG:COUN?MIN  
TRIG:COUN?MAX
```

Comma (,)

If a command requires several Parameter, then a comma must be used to separate adjacent Parameter.

Space

You must use blank characters, [TAB] or [Space] to separate Parameter with key words of commands.

Generic commands (*)

Execute functions like reset, self inspection and status operation. Generic commands always start with an asterisk (*) and occupy 3 character sizes, including one or more Parameter. Key words of a command and the first parameter are separated by a space. Semicolon (;) can separate several commands as follows:

```
*RST; *CLS; *ESE 32; *OPC?
```

Command terminator

Command strings sent to the instrument must end with a <Newline> (<NL>) character. IEEE-488 EOI (End or Identify) information can be used as <NL> character to replace termination command string of <NL> character. It is acceptable to place one <NL> after a <Enter>. Termination of command string always resets current SCPI command path to root level.

 **NOTE**

As for every SCPI message with one query sent to the instrument, the instrument will use a <NL> or newline sign (EOI) to terminate response of return. For example, if "DISP:TEXT?" is sent, <NL> will be placed after the returned data string to terminate response. If an SCPI message includes several queries separated by semicolon (such as "DISP?:DISP:TEXT?"), <NL> will terminate response returned after response to the last query. In all cases, the program must read <NL> in response before another command is sent to the instrument, otherwise errors will be caused.

1.7 Data Type

SCPI language defines several data types used for program message and response messages.

- Numerical parameter

Commands requiring numerical Parameter support the notations of all common decimal notations, including optional signs, decimal points, scientific notation, etc. Special values of numerical Parameter are also acceptable, such as MIN, MAX and DEF. In addition, suffixes for engineering units can also be sent together with numerical Parameter (including M, k, m or u). If the command accepts only some specific values, the instrument will automatically round the input Parameter to acceptable values. The following commands require numerical Parameter of frequency value:

[SOURce[1|2]:]FREQuency:CENTer {<Frequency>|MINimum|MAXimum}

- ◆ <NR1>: There is an implicit decimal point in the last bit, such as 273
- ◆ <NR2>: There is an explicit decimal point, such as .273
- ◆ <NR3>: There are an explicit decimal point and exponential, such as 2.73E+22.73E+2
- ◆ <Nrf>: The extensible form includes <NR1>, <NR2> and <NR3>, such as 273 273. 2.73E2273 273. 2.73E2
- ◆ <Nrf+>: The extensible decimal form includes <Nrf> and MIN MAX DEF, such as 273 273. 2.73E2 MAX. MIN and MAX are the minimum and maximum finite number. Within the range of the parameter definition, DEF is the default of the parameter.

- Discrete parameter

Discrete Parameter are used for settings with limited number of programming values (such as IMMEDIATE, EXTERNAL or BUS). They can use short and long format like key words of commands. They may be expressed in both upper and lower case. The query response always returns uppercase Parameter in short format. The following commands require discrete Parameter in voltage unit:

[SOURce[1|2]:]VOLTage:UNIT {VPP|VRMS|DBM}

- Boolean parameter

Boolean Parameter refer to true or false binary conditions. In case of false conditions, the instrument will accept "OFF" or "0". In case of true conditions, the instrument will accept "ON" or "1". In query of Boolean settings, the instrument will always return "0" or "1". Boolean Parameter are required by the following commands:

DISPlay {OFF|0|ON|1}

- ASCII string Parameter

String Parameter may actually include all ASCII character sets. Character strings must start and end with paired quotation marks; and single quotation marks or double quotation marks are both allowed. Quotation mark separators

may also act as one part of a string, they can be typed twice without any character added between them. String parameter is used in the following command:

```
DISPlay:TEXT <quoted string>
```

For example, the following commands display message of "WAITING..." (without quotation marks) on the front panel of the instrument.

```
DISP:TEXT "WAITING..."
```

Single quotation marks may also be used to display the same message.

```
DISP:TEXT 'WAITING...'
```

1.8 Communication Interface

Four standard interfaces are equipped for IT5101: GPIB, USB, LAN and RS232. Users can choose any of the USB, GPIB, RS232 and LAN to achieve the communication with PC.

USB Interface

Use a cable with two USB ports to connect internal resistance tester and PC. You can program through USB interface to achieve all functions of internal resistance tester.

The functions of USB488 interface are as follows:

Interface is 488.2 USB488 interface

Receive the following request: REN_CONTROL, GO_TO_LOCAL, and LOCAL_LOCKOUT

When the interface receives MsgID = TRIGGER USBTMC command, it will transmit the TRIGGER command to the function layer

The functions of internal resistance tester's USB488 are as follows:

receive all SCPI commands

device is SR1 enabled

device is RL1 enabled

device is DT1 enabled

GPIB Interface

Use a IEEE488 bus to connect GPIB interfaces of internal resistance tester and PC. Please ensure that the screws have been screwed down in order to have a full connection. Then press **[Menu]** to enter the system menu and press **[Comm Set]** to set the GPIB address. The address range of internal resistance tester is 0-99. After you set the address, please press **[Enter]** button to confirm. GPIB address is saved in nonvolatile memory.

LAN Interface

Press **[Menu]** > **[Comm Set]** button to enter the system set. Please select "LAN" in the Communication from System and then configure Gateway, IP, Mask and SocketPort in the LAN option.

Connect the LAN interface of internal resistance tester to the computer with a reticle (crossed). The gateway address should be consistent with that of the PC, and the IP address should be at the same network segment with the PC's IP address.

Chapter2 System Command

SYSTem:BEEPer :STATe <1|0|ON|OFF>

This command is used to turn on/turn off the beeper, when the arguments is set to 1/ON, the beeper is enabled and press keyboard will beeper, otherwise, it is mute.

Command syntax

SYSTem:BEEPer:STATe <1|0|ON|OFF>

Query syntax

SYSTem:BEEPer:STATe?

Arguments

1|0|ON|OFF

Example

SYSTem:BEEPer:STATe ON

Query command

SYSTem:BEEPer:STATe?

Arguments

ON

SYSTem:LFRequency <50|60>

This command is used to set and query the frequency of AC power.

Command syntax

SYSTem:LFRequency <50|60>

Query syntax

SYSTem:LFRequency?

Arguments

50|60

Example

SYSTem:LFRequency 50

Query command

SYSTem:LFRequency?

Arguments

50

SYSTem:KLOCK <1|0|ON|OFF>

This command is used to lock buttons on the front panel or query the state of buttons.

Command syntax

SYSTem:KLOCK <1|0|ON|OFF>

Query syntax

SYSTem:KLOCK?

Arguments

1|0|ON|OFF

SYSTem:ELOCK <1|0|ON|OFF>

This command is used to lock system I/O interface on the rear panel or query the state of the interface.

Command syntax

SYSTem:ELOCK <1|0|ON|OFF>

Query syntax

SYSTem:ELOCK?

Arguments

1|0|ON|OFF

SYSTem:LOCal

This command is used to switch the instrument to local control mode (control from panel). In this mode, all buttons on the front panel is valid.

Command syntax

SYSTem:LOCal

Arguments

NONE

Example

Syst:loc

Arguments

NONE

SYSTem:SAVE <1-126>

This command is used to save the measurement conditions.

Command syntax

SYSTem:SAVE <1-126>

Query syntax

SYSTem:SAVE?

Arguments

1-126

Example

SYSTem:SAVE 100

Query command

SYSTem:SAVE?

Arguments

100

SYSTem:READ <1-126>

This command is used to read the measurement conditions.

Command syntax

SYSTem:READ <1-126>

Query syntax

SYSTem: READ?

Arguments

1-126

Example

SYSTem:READ 100

Query command

SYSTem:READ?

Arguments

100

SYSTem:BACKup

This command is used to back up the measurement conditions.

Command syntax

SYSTem:BACKup

Query syntax

SYSTem:BACKup?

Arguments

NONE

SYSTem:HEADer <1|0|ON|OFF>

This command is used to set or query the infoheader.

Command syntax

SYSTem:HEADer <1|0|ON|OFF>

Query syntax

SYSTem:HEADer?

Arguments

1|0|ON|OFF

SYSTem:ERRor <ASYNchronous|SYNChronous>

This command is used to set or query error timing.

Command syntax

SYSTem:ERRor <ASYNchronous|SYNChronous>

Query syntax

SYSTem:ERRor?

Arguments

ASYNchronous|SYNChronous

SYSTem:TERMinator <0|1>

This command is used to set or query terminator.

Command syntax

SYSTem:TERMinator

Query syntax

SYSTem:TERMinator?

Arguments

0|1

SYSTem:EOM:MODE <HOLD|PULSe>

This command is used to set the mode of EOM.

Command syntax

SYSTem:EOM:MODE <HOLD|PULSe>

Query syntax

SYSTem:EOM:MODE?

Arguments

<HOLD|PULSE>

HOLD: Holds until the next trigger is detected.

PULSE: Remains only for the specified pulse width.

Example

SYSTem:EOM:MODE PULS

SYSTem:EOM:PULSe <NR2>

This command is used to set the pulse width of EOM.

Command syntax

SYSTem:EOM:PULSe <NR2>

Query syntax

SYSTem:EOM:PULSe?

Arguments

0.001s to 0.099s

Example

SYSTem:EOM:PULS 0.005

SYSTem:CURRent <CONTInuous|PLUSe>

This command is used to set or query current pulse.

Command syntax

SYSTem:CURRent <CONTInuous|PLUSe>

Query syntax

SYSTem:CURRent?

Arguments

CONTInuous|PLUSe

SYSTem:RESet

This command is used to reset the system parameters.

Command syntax

SYSTem:RESet

Query syntax

SYSTem:RESet ?

Arguments

NONE

IO:OUT<0-1024>

This command is used to output the EXT I/O.

Command syntax

IO:OUT<0-1024>

Query syntax

IO:OUT ?

Arguments

0-1024

IO:IN?

This command is used to input the EXT I/O.

Command syntax

IO:IN?

Arguments

NONE

INITiate:CONTInuous<1|0|ON|OFF>

This command is used to set and query the continuous measurement.

Command syntax

INITiate:CONTInuous

Query syntax

INITiate:CONTInuous?

Arguments

1|0|ON|OFF

INITiate[:IMMediate]

This command is used to set the trigger.

Command syntax

INITiate[:IMMediate]

Arguments

NONE

TRIGger:SOURce<IMMediate|EXTernal>

This command is used to set and query the trigger source.

Command syntax

TRIGger:SOURce <IMMediate|EXTernal>

Query syntax

TRIGger:SOURce?

Arguments

IMMediate|EXTernal

TRIGger:DELay:STATe<1|0|ON|OFF>

This command is used to set and query the trigger delay.

Command syntax

TRIGger:DELay:STATe<1|0|ON|OFF>

Query syntax

TRIGger:DELay:STATe?

Arguments

1|0|ON|OFF

TRIGger:DELay<0-9.999>

This command is used to set and query the time of trigger delay.

Command syntax

TRIGger:DELay<0-9.999>

Query syntax

TRIGger:DELay?

Arguments

NONE

FETCh?

This command is used to read the present measurement values.

Command syntax

FETCh?

Arguments

NONE

READ?

This command is used to read the measurement values.

Command syntax

READ?

Arguments

NONE

Chapter3 Configuration Commands

ESE0 <0-255>

This command is used to set and query event register ESER0.

Command syntax

ESE0 <0-255>

Query syntax

ESE0?

Arguments

0-255

Example

ESE0 100

Query command

ESE0?

Arguments

100

ESE1 <0-255>

This command is used to set and query event register ESER1.

Command syntax

ESE1 <0-255>

Query syntax

ESE1?

Arguments

0-255

Example

ESE1 120

Query command

ESE1?

Arguments

120

FUNCTION <RV|RESistance|VOLTage>

This command is used to set and query measurement function.

Command syntax

FUNCTION <RV|RESistance|VOLTage>

Query syntax

FUNCTION?

Arguments

RV|RESistance|VOLTage

Example

FUNCTION RESistance

Query command

FUNCTION?

Arguments

RESistance

RESistance:RANGe <0-3100>

RESistance:RANGe<0-3.1>

This command is used to set and query the range of resistance. The resistance range of IT5101/IT5101H model and IT5101E model is not the same. The command of IT5101/IT5101H is: RESistance:RANGe <0-3100>, The command of IT5101E is: RESistance:RANGe<0-3.1>.

Command syntax

RESistance:RANGe <0-3100>

RESistance:RANGe<0-3.1>

Query syntax

RESistance:RANGe?

Arguments

IT5101/IT5101H:

3.0000E-3/30.000E-3/300.00E-3/3.0000E+0/30.000E+0/300.00E+0/3.000E+3

IT5101E:300.00E-3/3.0000E+0

Example

RESistance:RANGe 120E-3

Set the resistance range to exceed 120mΩ.

Query command

RESistance:RANGe?

Arguments

300.00E-3

The present resistance range is 300mΩ.

VOLTage:RANGe <-300 - 300>

VOLTage:RANGe <-1000~1000>

This command is used to set and query the range of voltage.

The command of IT5101/IT5101E model: VOLTage:RANGe <-300~300>,
The command of IT5101H model: VOLTage:RANGe <-1000~1000>.

Command syntax

VOLTage:RANGe <-300~300>

VOLTage:RANGe <-1000~1000>

Query syntax

VOLTage:RANGe?

Arguments

IT5101/IT5101E: 6.00000E+0/60.0000E+0/300.000E+0

IT5101H: 10.00000E+0/100.0000E+0/1000.000E+0

Example

VOLTage:RANGe 15

Query command

VOLTage:RANGe?

Arguments

IT5101/IT5101E: 60.0000E+0

IT5101H: 100.0000E+0

AUTorange <1|0|ON|OFF>

This command is used to set and query the autorange.



This command is common for the autorange of resistance and voltage. The separate commands are as follows.

When the compare function is turned on, if you turn on the autorange, the compare function will turn off automatically.

Command syntax

AUTorange <1|0|ON|OFF>

Query syntax

AUTorange?

Arguments

1|0|ON|OFF

Example

AUTorange ON

Query command

AUTorange?

Arguments

ON

AUTorange:VOLTage <1|0|ON|OFF>

This command is used to set and query the autorange of voltage. When the compare function is turned on, if you turn on the autorange, the compare function will turn off automatically.

Command syntax

AUTorange:VOLTage <1|0|ON|OFF>

Query syntax

AUTorange:VOLTage?

Arguments

1|0|ON|OFF

AUTorange:RESistance <1|0|ON|OFF>

This command is used to set and query the autorange of resistance. When the compare function is turned on, if you turn on the autorange, the compare function will turn off automatically.

Command syntax

AUTorange:RESistance <1|0|ON|OFF>

Query syntax

AUTorange:RESistance?

Arguments

1|0|ON|OFF

ADJust:CLEAr

This command is used to clear the state of adjusting to zero.

Command syntax

ADJust:CLEAr

Query syntax

ADJust?

Arguments

NONE

ADJust?

This command is used to adjust to zero and query the result.

Command syntax

ADJust?

Returns

0|1

0: OK

1: Failure



Note

The instrument needs a while for adjusting to zero. Please check the returns after setting the time interval or set the overtime interval to 8 seconds..

SAMPIe:RATE <SLOW|MEDIum|FAST|EXFast>

This command is used to set or query the sample speed.

Command syntax

SAMPIe:RATE <SLOW|MEDIum|FAST|EXFast>

Query syntax

SAMPIe:RATE?

Arguments

SLOW|MEDIum|FAST|EXFast

Example

SAMPIe:RATE SLOW

Query command

SAMPLE:RATE?

Arguments

SLOW

CALCulate:AVERage:STATE <1|0|ON|OFF>

This command is used to set or query the average function.

Command syntax

CALCulate:AVERage:STATE <1|0|ON|OFF>

Query syntax

CALCulate:AVERage:STATE?

Arguments

1|0|ON|OFF

Example

CALCulate:AVERage:STATE ON

Query command

CALCulate:AVERage:STATE?

Arguments

ON

CALCulate:AVERage <2-16>

This command is used to set or query the average count.

Command syntax

CALCulate:AVERage <2-16>

Query syntax

CALCulate:AVERage?

Arguments

2-16

Example

CALCulate:AVERage 5

Query command

CALCulate:AVERage?

Arguments

5

CALCulate:LIMit:STATe <1|0|ON|OFF>

This command is used to set or query comparer.

Command syntax

CALCulate:LIMit:STATe <1|0|ON|OFF>

Query syntax

CALCulate:LIMit:STATe?

Arguments

1|0|ON|OFF

Example

CALCulate:LIMit:STATe ON

Query command

CALCulate:LIMit:STATe?

Arguments

ON

CALCulate:LIMit:ALARm <DISPlay|BEEPer|ALL>

This command is used to set or query the comparer alarm.

Command syntax

CALCulate:LIMit:ALARm <DISPlay|BEEPer|ALL>

Query syntax

CALCulate:LIMit:ALARm?

Arguments

DISPlay|BEEPer|ALL

Example

CALCulate:LIMit:ALARm DISPlay

Query command

CALCulate:LIMit:ALARm?

Arguments

DISPlay

CALCulate:LIMit:RESistance:MODE <HL|REF>

This command is used to set or query the resistance mode of comparer.

Command syntax

```
CALCulate:LIMit:RESistance:MODE <HL|REF>
```

Query syntax

```
CALCulate:LIMit:RESistance:MODE?
```

Arguments

HL|REF

Example

```
CALCulate:LIMit:RESistance:MODE HL
```

Query command

```
CALCulate:LIMit:RESistance:MODE?
```

Arguments

HL

CALCulate:LIMit:VOLTage:MODE <HL|REF>

This command is used to set or query the voltage mode of comparer.

Command syntax

```
CALCulate:LIMit:VOLTage:MODE <HL|REF>
```

Query syntax

```
CALCulate:LIMit:VOLTage:MODE?
```

Arguments

HL|REF

Example

```
CALCulate:LIMit:VOLTage:MODE HL
```

Query command

```
CALCulate:LIMit:VOLTage:MODE?
```

Arguments

HL

CALCulate:LIMit:RESistance:UNIT <MR|R>

This command is used to set or query the unit of resistance of comparer.

Command syntax

CALCulate:LIMit:RESistance:UNIT <MR|R>

Query syntax

CALCulate:LIMit:RESistance:UNIT?

Arguments

MR|R

Example

CALCulate:LIMit:RESistance:UNIT R

Query command

CALCulate:LIMit:RESistance:UNIT?

Arguments

R

CALCulate:LIMit:RESistance:UPPer <0-99999>

This command is used to set or query the upper limit of resistance of comparer.

Command syntax

CALCulate:LIMit:RESistance:UPPer <0-99999>

Query syntax

CALCulate:LIMit:RESistance:UPPer?

Arguments

0-99999

Example

CALCulate:LIMit:RESistance:UPPer 28000

Set the upper limit to 280.00mΩ. (When the range is 0-300mΩ)

If the present range is 0-3Ω, the upper limit is 2.8000Ω.

Query command

CALCulate:LIMit:RESistance:UPPer?

Arguments

28000

CALCulate:LIMit:VOLTage:UPPer <0-999999>

This command is used to set or query the upper limit of voltage of

comparer.

Command syntax

CALCulate:LIMit:VOLTage:UPPer <0-999999>

Query syntax

CALCulate:LIMit:VOLTage:UPPer?

Arguments

0-999999

Example

CALCulate:LIMit:VOLTage:UPPer 280000

Set the upper limit to 2.80000V. (When the range is 0-6V)

Query command

CALCulate:LIMit:VOLTage:UPPer?

Arguments

280000

CALCulate:LIMit:RESistance:LOWer <0-99999>

This command is used to set or query the lower limit of resistance of comparer.

Command syntax

CALCulate:LIMit:RESistance:LOWer <0-99999>

Query syntax

CALCulate:LIMit:RESistance:LOWer?

Arguments

0-99999

Example

CALCulate:LIMit:RESistance:LOWer 28000

Set the lower limit to 280.00mΩ. (When the range is 0-300mΩ)

If the present range is 0-3Ω, the lower limit is 2.8000Ω.

Query command

CALCulate:LIMit:RESistance:LOWer?

Arguments

28000

CALCulate:LIMit:VOLTage:LOWer <0-999999>

This command is used to set or query the lower limit of voltage of comparer.

Command syntax

CALCulate:LIMit:VOLTage:LOWer <0-999999>

Query syntax

CALCulate:LIMit:VOLTage:LOWer?

Arguments

0-999999

Example

CALCulate:LIMit:VOLTage:LOWer 280000

Set the lower limit to 2.80000V. (When the range is 0-6V)

Query command

CALCulate:LIMit:VOLTage:LOWer?

Arguments

280000

CALCulate:LIMit:RESistance:REFerence<0-99999>

This command is used to set or query the reference value of resistance of comparer.

Command syntax

CALCulate:LIMit:RESistance:REFerence <0-99999>

Query syntax

CALCulate:LIMit:RESistance:REFerence?

Arguments

0-99999

Example

CALCulate:LIMit:RESistance:REFerence 1234

Set the reference value to 12.34m Ω . (When the range is 0-300m Ω)

If the present range is 0-3 Ω , the reference value is 0.1234 Ω .

Query command

CALCulate:LIMit:RESistance:REFerence?

Arguments

1234

CALCulate:LIMit:VOLTage:REFerence <0-999999>

This command is used to set or query the reference value of voltage of comparer.

Command syntax

CALCulate:LIMit:VOLTage:REFerence <0-999999>

Query syntax

CALCulate:LIMit:VOLTage:REFerence?

Arguments

0-999999

Example

CALCulate:LIMit:VOLTage:REFerence 123456

Set the reference value to 1.23456V. (When the range is 0-6V)

Query command

CALCulate:LIMit:VOLTage:REFerence?

Arguments

123456

CALCulate:LIMit:RESistance:PERCent <0-99.9999>

This command is used to set or query the range of resistance of comparer.

Command syntax

CALCulate:LIMit:RESistance:PERCent <0-99.9999>

Query syntax

CALCulate:LIMit:RESistance:PERCent?

Arguments

0-99.9999

Example

CALCulate:LIMit:RESistance:PERCent 12.34

Query command

CALCulate:LIMit:RESistance:PERCent?

Arguments

12.34

CALCulate:LIMit:VOLTage:PERCent <0-99.9999>

This command is used to set or query the range of voltage of comparer.

Command syntax

CALCulate:LIMit:VOLTage:PERCent <0-99.9999>

Query syntax

CALCulate:LIMit:VOLTage:PERCent?

Arguments

0-99.9999

Example

CALCulate:LIMit:VOLTage:PERCent 12.34

Query command

CALCulate:LIMit:VOLTage:PERCent?

Arguments

12.34

CALCulate:LIMit:RESistance:RESult?

This command is used to set or query the result of resistance of comparer.

Command syntax

CALCulate:LIMit:RESistance:RESult?

Query syntax

CALCulate:LIMit:RESistance:RESult?

Arguments

NONE

Example

CALCulate:LIMit:RESistance:RESult?

Query command

CALCulate:LIMit:RESistance:RESult?

CALCulate:LIMit:VOLTage:RESult?

This command is used to set or query the result of voltage of comparer.

Command syntax

CALCulate:LIMit:VOLTage:RESult?

Query syntax

CALCulate:LIMit:VOLTage:RESult?

Arguments

NONE

Example

CALCulate:LIMit:VOLTage:RESult?

Query command

CALCulate:LIMit:VOLTage:RESult?

CALCulate:LIMit:ABS <1/0/ON/OFF>

This command is used to set or query the judgment function of absolute value of comparer.

Command syntax

CALCulate:LIMit:ABS <1/0/ON/OFF>

Query syntax

CALCulate:LIMit:ABS?

Arguments

1/0

Example

CALCulate:LIMit:ABS ON

CALCulate:STATistics:STATe <1|0|ON|OFF>

This command is used to set or query the statistics function.

Command syntax

CALCulate:STATistics:STATe <1|0|ON|OFF>

Query syntax

CALCulate:STATistics:STATe?

Arguments

1|0|ON|OFF

Example

CALCulate:STATistics:STATe ON

Query command

CALCulate:STATistics:STATe?

Arguments

ON

CALCulate:STATistics:CLEAR

This command is used to clear the result of statistics function.

Command syntax

CALCulate:STATistics:CLEAR

Query syntax

CALCulate:STATistics:CLEAR?

Arguments

NONE

Example

CALCulate:STATistics:CLEAR

Query command

CALCulate:STATistics:CLEAR?

CALCulate:STATistics:RESistance:NUMBER?

This command is used to query the number of resistance.

Command syntax

CALCulate:STATistics:RESistance:NUMBER?

Returns

<total number (NR1) >, <valid number (NR1) >

CALCulate:STATistics:VOLTage:NUMBER?

This command is used to query the number of voltage.

Command syntax

CALCulate:STATistics:VOLTage:NUMBER?

Returns

<total number (NR1) >, <valid number (NR1) >

CALCulate:STATistics:RESistance:MEAN?

This command is used to query the mean of resistance.

Command syntax

```
CALCulate:STATistics:RESistance:MEAN?
```

Returns

```
<mean (NR3) >
```

CALCulate:STATistics:VOLTage:MEAN?

This command is used to query the mean of voltage.

Command syntax

```
CALCulate:STATistics:VOLTage:MEAN?
```

Returns

```
<mean (NR3) >
```

CALCulate:STATistics:RESistance:MAXimum?

This command is used to query the maximum of resistance.

Command syntax

```
CALCulate:STATistics:RESistance:MAXimum?
```

Returns

```
<maximum (NR3) >, <the number of the maximum (NR1) >
```

CALCulate:STATistics:VOLTage:MAXimum?

This command is used to query the maximum of voltage.

Command syntax

```
CALCulate:STATistics:VOLTage:MAXimum?
```

Returns

```
< maximum (NR3) >, < the number of the maximum (NR1) >
```

CALCulate:STATistics:RESistance:MINimum?

This command is used to query the minimum of resistance.

Command syntax

```
CALCulate:STATistics:RESistance:MINimum?
```

Returns

< minimum (NR3) >, < the number of the minimum (NR1) >

CALCulate:STATistics:VOLTage:MINimum?

This command is used to query the minimum of voltage.

Command syntax

CALCulate:STATistics:VOLTage:MINimum?

Returns

< minimum (NR3) >, < the number of the minimum (NR1) >

CALCulate:STATistics:RESistance:LIMit?

This command is used to query the judgment result of resistance.

Command syntax

CALCulate:STATistics:RESistance:LIMit?

Returns

<Hi data (NR1) >, <IN data (NR1) >, <Lo data (NR1) >, <abnormal data (NR1) >

CALCulate:STATistics:VOLTage:LIMit?

This command is used to query the judgment result of voltage.

Command syntax

CALCulate:STATistics:VOLTage:LIMit?

Returns

<Hi data (NR1) >, <IN data (NR1) >, <Lo data (NR1) >, <abnormal data (NR1) >

CALCulate:STATistics:RESistance:DEViation?

This command is used to query the standard deviation of resistance.

Command syntax

CALCulate:STATistics:RESistance:DEViation?

Returns

< σ_n (NR3) >, < σ_{n-1} (NR3)>

CALCulate:STATistics:VOLTage:DEViation?

This command is used to query the standard deviation of voltage.

Command syntax

CALCulate:STATistics:VOLTage:DEViation?

Returns

$\langle \sigma_n \text{ (NR3)} \rangle$, $\langle \sigma_{n-1} \text{ (NR3)} \rangle$

CALCulate:STATistics:RESistance:CP?

This command is used to query process capability index of resistance.

Command syntax

CALCulate:STATistics:RESistance:CP?

Returns

$\langle Cp \text{ (NR2)} \rangle$, $\langle CpK \text{ (NR2)} \rangle$

CALCulate:STATistics:VOLTage:CP?

This command is used to query process capability index of voltage.

Command syntax

CALCulate:STATistics:VOLTage:CP?

Returns

$\langle Cp \text{ (NR2)} \rangle$, $\langle CpK \text{ (NR2)} \rangle$

MEMory:STATe <1|0|ON|OFF>

This command is used to set the status of the register function. When it is set to ON, the storage function of the memory is enabled. Otherwise, register data cannot be read.

Command syntax

MEMory:STATe <1|0|ON|OFF>

Query command

MEMory:STATe?

Arguments

<1|0|ON|OFF>

MEMory:CLEAR

This command is used to clear the data storage.

Command syntax

MEMory:CLEAR

Arguments

NONE

MEMory:COUNT?

This command is used to query the data storage.

Command syntax

MEMory:COUNT?

Returns

< data storage >

< data storage >=0~400 (NR1)

MEMory:DATA?

This command is used to query the measurement data.

Command syntax

MEMory:DATA?

Returns

<storage number>,<resistance measurement>,<voltage measurement>

Example

MEM:DATA?

Returns

1,290.60E-3,1.3324E+0

2,290.60E-3,1.3324E+0

Chapter4 IEEE-488 Commands

This chapter introduces often-used IEEE-488 commands.

***IDN?**

This command can read information about internal resistance tester. The returns parameter contains 4 segments divided by comma.

Query syntax

*IDN?

Arguments

NONE

Returns

<AARD>

Example

ITECH,IT5101,KN34243232,01.00

***RST**

This command resets the internal resistance tester to default settings.

Command syntax

*RST

Arguments

NONE

***TST**

This command is used to query the self-test by the instrument.

Command syntax

*TST

Query syntax

*TST?

Arguments

<0~3>
0: OK
1: RAM error
2: EEPROM error
3: RAM error、EEPROM error

***WAI**

This command instructs the internal resistance tester not to process any further commands until all pending operations are completed. Pending operations are as defined under the *OPC command. *WAI can be aborted only by sending the internal resistance tester a device clear command.

Command syntax

*WAI

Arguments

NONE

Related Command

*OPC

***CLS**

This command clears the following registers:

- Standard event register
- Query event register
- Status byte register

Command syntax

*CLS

Arguments

NONE

***ESE <0-255>**

This command can set the parameter of standard event enable register.

Command syntax

*ESE <0-255>

Query syntax

*ESE?

Arguments

0~255

Example

*ESE 100

Query command

*ESE?

Arguments

100

***ESR <0-255>**

This command can read the value of standard event status register.

Command syntax

*ESR <0-255>

Query syntax

* ESR?

Arguments

0-255

Example

*ESR 100

Query command

*ESR?

Arguments

100

***SRE <0-255>**

This command can set the parameter of state byte enable register. Setting parameter can determine which byte value of state byte register is 1 and the byte will set RQS of state byte register to 1. Bit definition of state byte enable register is as the same as the state byte register.

Command syntax

*SRE <0-255>

Query syntax

*SRE?

Arguments

0-255

Example

*SRE 100

Query command

*SRE?

Arguments

100

***STB?**

This command can read the data from status byte register. After executing this command, the value of bit6 in status byte register will be cleaned.

Query syntax

*STB?

Arguments

NONE

Returns

<NR1>

Related Command

*CLS *ESE *ESR

***TRG**

This command is used to trigger the measurement and read the data in the measurement.

Command syntax

*TRG

Arguments

NONE

Contact US

Thank you for purchasing ITECH products.If you have any doubt about this product, please contact us as follow.

1. Please refer to the CD-ROM of related user's manual in package.
2. Visit ITECH website www.itechate.com .
3. Select the most convenient contact for further consultation.